



Mohs Microscope

MIS-5000



Operation Manual

This instruction manual is for the Model MIS-5000 Microscope. To ensure safety and obtain optimum performance and to familiarize yourself fully with use of this microscope, we recommend that you review this manual thoroughly before operating the microscope. Retain this instruction manual in an easily accessible place near the work desk for future reference.

I. Specifications		MIS-5000	MIS-5000T
		Viewing head	Compensation free Binocular head, inclined at 30° (55mm-75mm)
	Compensation free Trinocular head, inclined at 30° (55mm-75mm)		●
Eyepiece	WF10×/22	●	●
Nosepiece	Quadruple nosepiece	●	●
Objective	Plan Achromatic objectives: 2X, 4X, 10X, and 40X(R)	●	●
	Plan Infinity achromatic objectives: 2X, 4X, 10X, and 40X(R)		
Stage	Double layers mechanical stage Stage size: 180mm×150mm Moving range: 75mm×50mm	●	●
Condenser	Swing type N.A.1.25 Abbe condenser with iris diaphragm & filter	●	●
Focusing	Coaxial coarse & fine focusing adjustment with rack and pinion mechanism. Fine focusing scale value 0.002mm	●	●
Light Source	Halogen bulb 12V 30W AC 85V-230V Adjustable brightness	●	●
Collector	High brightness Kohler illumination	●	●

II. Objectives

Type	Magnification	Numerical Aperture (N.A)	Working Distance (mm)	Thickness of the cover slip (mm)
Plan achromatic objective	2X	0.05	8.00	0.17
	4X	0.1	7.18	0.17
	10X	0.25	4.80	0.17
	40X(S)	0.65	0.68	0.17

Structure of MIS-5000, Binocular

MIS-5000

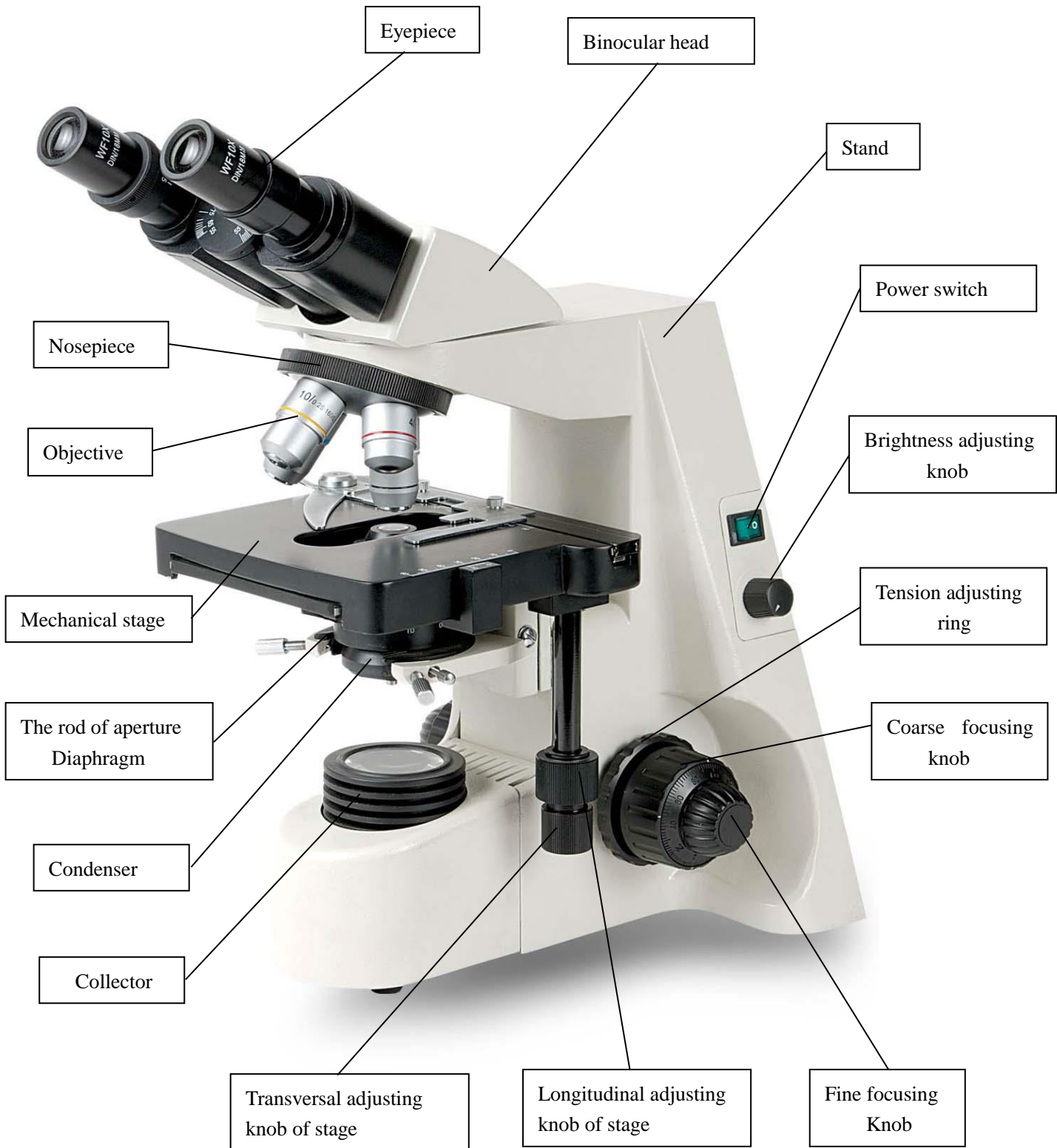

Structure of MIS-5000T, Trinocular

MIS-5000T

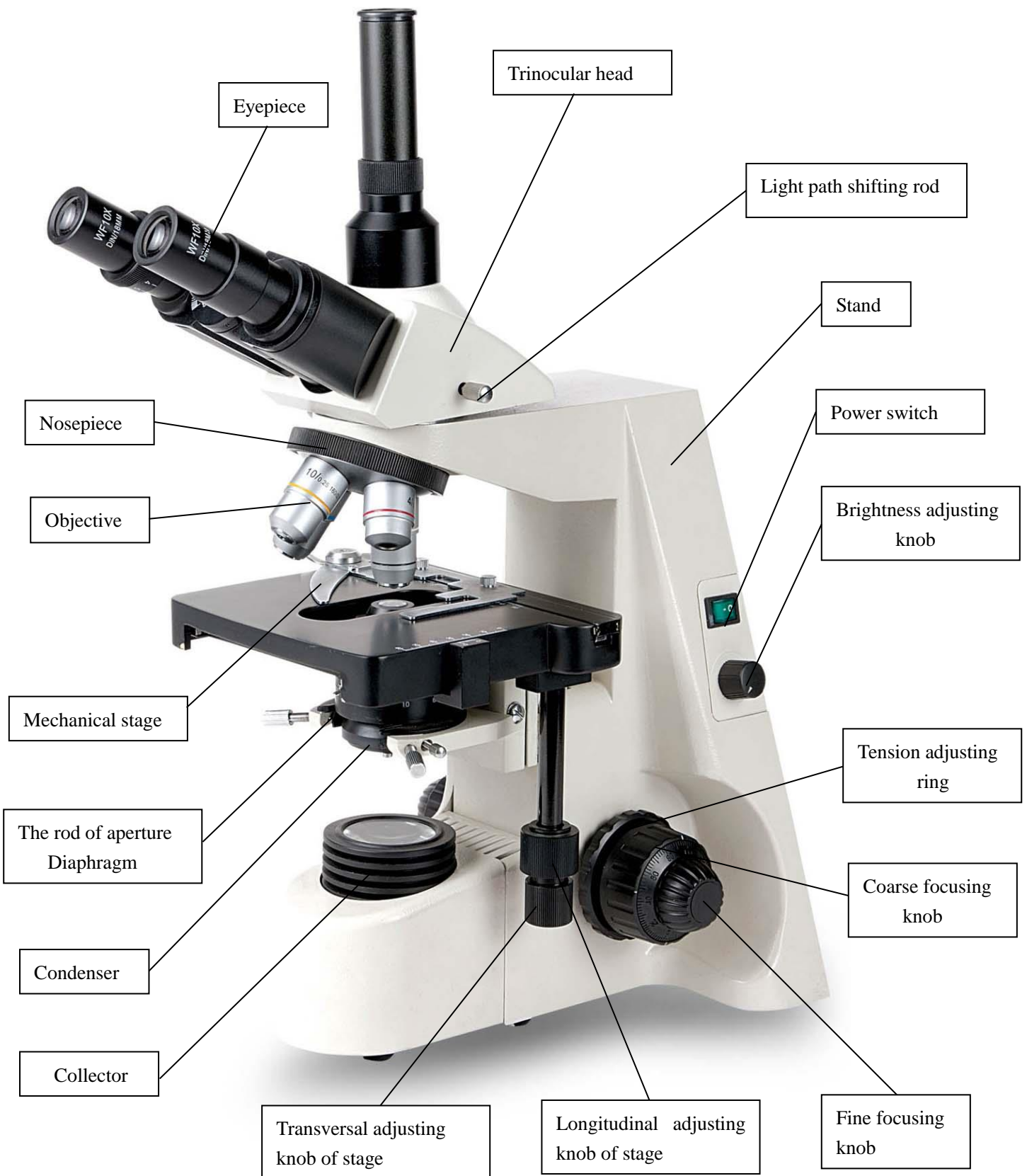

III. Application

Model MIS-5000 series biological microscopes are specially designed for MOHS application and other clinical examination and teaching demonstrations in laboratories, colleges and medical fields. They are also ideal instruments for biological, bacteriological, pathological, and pharmaceutical research. Because of higher capability with lower price and humanized configuration design, it is an ideal choice for individuals, schools and scientific research organizations.

IV. Before Use

4-1. Operation

- (1) As the microscope is a precision instrument, always use it with care. Avoid dropping or shaking during operation. Make sure the microscope is placed on a flat surface.
- (2) Do not put the microscope in direct contact with the sun. Do not expose the microscope to high temperature, damp, or dusty environment.
- (3) When moving the microscope, you should use both hands, typically one hand under the base and one hand on the arm (stand) of the microscope and set it down carefully.

★It will damage the microscope if you hold the microscope either by the stage, focusing knob or head.

- (4) Make sure the microscope is unplugged before replacing the bulb or fuse and wait until the bulb has cooled down.

★Lamp selected only: 12V/30W Halogen Bulb

- (5) This microscope has a built in dual voltage transformer and can be used with wide voltage range from 85 to 230V.
- (6) Use only electrical plug supplied with the microscope.

4-2 Maintenance

- (1) Wipe the lens gently with a soft lens tissue. After every use with oil or fingerprints clean the lens surfaces with lens paper or lens paper moistened with a little rubbing alcohol. If you do not have lens paper make sure to use a lint free towel or cloth.

★ Alcohol is flammable. Do not place this chemical near fire or fire causing source. You should use this chemical in a ventilated place.

- (2) Don't use organic solution to wipe the surfaces of the other components.
- (3) If the microscope comes in contact with a liquid, then you should turn off the power immediately and wipe it dry.
- (4) Never disassemble or service the microscope yourself.
- (5) After using, cover the microscope with a dust cover.

V. Assembly

5-1 Install the Objectives

Install the objective into the microscope nosepiece from the lowest magnification to the highest, in a clockwise direction.

5-2 Insert the Eyepieces

- (1) Remove the eyepiece tube covers.
- (2) Insert the eyepiece into the tube completely.

5-3 Install head

Put the binocular head or the trinocular head into the head holder, tighten the screw with finger.

5-4 Install plug

- (1) Insert one side of the plug into the back socket of the microscope
- (2) Plug power cord into the power supply socket.

Note: a) The microscope must be grounded.

b) Make sure the power voltage is in accordance with the microscope's marking voltage.

VI. Using the Instrument

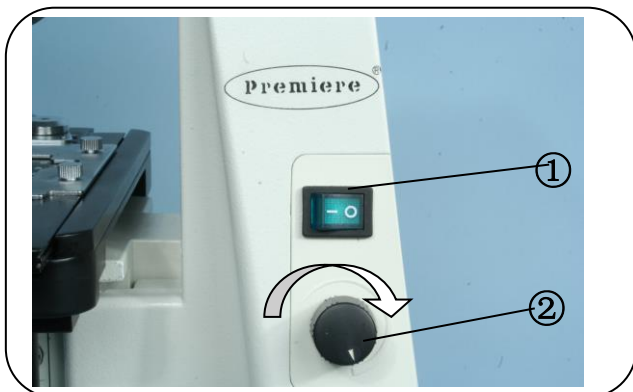

Fig. 1.

1. Brightness adjustment (Fig. 1.)

1. Press main power switch ① to the “I” position.
2. Turn the brightness knob ② in the direction of the arrow to increase the amount of light coming through the light source.

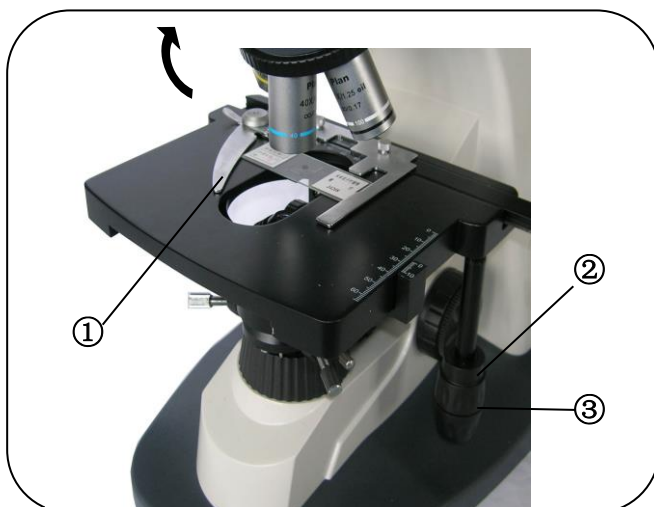

Fig. 2.

2. Specimen viewing (Fig. 2.)

1. Using the coarse focusing knob lower the stage to the lowest position.
2. Open the spring clamp ① as per the direction of the arrow and put the specimen on the stage cover slide side up
3. Allow the spring clamp to close to hold the slide in place
4. Move the mechanical stage control knobs ② & ③ and to move the specimen left and right or back and forth

Please do not move mechanical stage with your hands, this could cause damage to the mechanical stage.

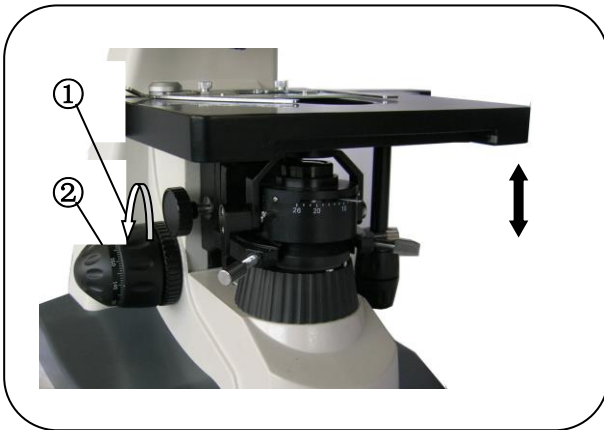

Fig. 3.

3. Focusing (Fig. 3.)

1. First look down to make sure the specimen is lined up with the light coming up from the bottom. Then switch the objective to 2X and use the coarse focusing knob ① as per arrowhead.
2. After finding the specimen with the course focus, use the fine focus to make the image clearer ②

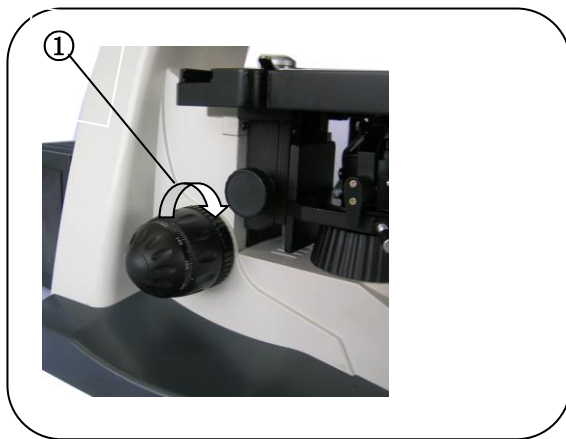

Fig. 4.

4. Adjusting tension of coarse focusing knob (Fig. 4.)

1. The tension of the coarse focusing knob can be adjusted. Adjust the outer ring ① as shown by the arrow to increase tension and turn the outer ring in the opposite direction to decrease the tension
2. If you find the stage drifts down automatically or the image becomes blurry immediately after fine focusing, it is caused by the tension control being too loose, please tighten the tension ring as per arrowhead direction



Fig. 5.

5. Interpupillary distance adjustment (Fig. 5.)

Adjust the binocular head to fit the distance between your eyes. When observing with both eyes hold the bases of the eyetubes and rotate them around the axis until there is only one field of view. On the left and right eyepiece base should point to the same number. The number is the interpupillary distance.

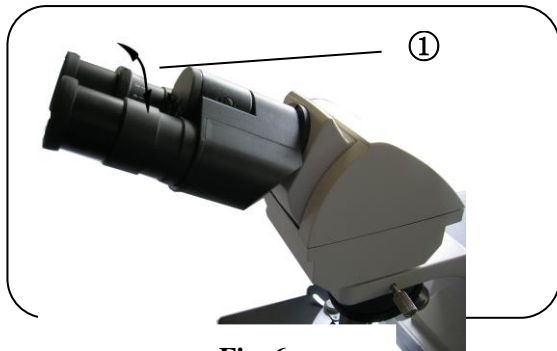

Fig. 6.

6. Diopter adjustment (Fig. 6.)

1. First view the specimen through the right eyepiece with your right eye. Now use the coarse & fine focusing until you see the specimen clearly.
2. Then observe left eyepiece with your left eye, and rotate the Diopter ring ① to make specimen clearer, if not already clear.



Fig. 7.

7. Rubber Eyeguards (Fig. 7)

For people that wear glasses

The eyeguards can be folded (prevent glasses from touching eyepiece directly)

For people without glasses

Eyeguards can prevent incident light between your eyes and the eyepiece, making observation better.

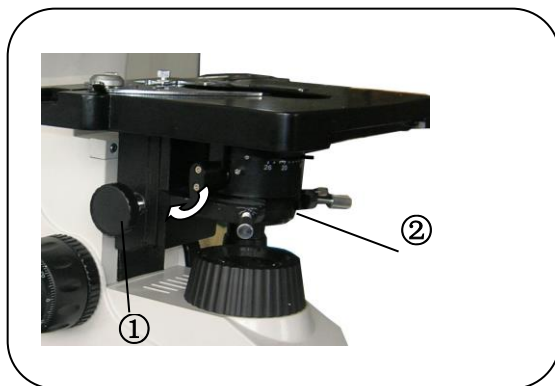

Fig. 8.

8. Condenser adjustment (Fig. 8.)

In general, the condenser is used at the highest position, but when observing a specimen that does not have uniform light, lower the condenser to get better illumination.

1. Move the condenser to the top by adjusting the condenser control knob ①
2. Rotate the iris diaphragm of the condenser to make the aperture diaphragm consistent with numeral aperture of the objective to get a clear and sharp image. ②
3. When using the 2X or 4X objective, swing out the condenser as shown with the arrow for more illumination.



Fig. 9.

9. Mounting filters (Fig. 9.)

1. Swing out the filter holder
2. Insert the color filter
3. Swing the filter holder back into place underneath the condenser.

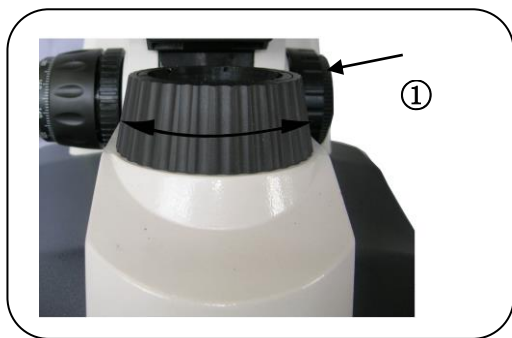

Fig. 10.

10. Field diaphragm adjustment (Fig. 10.)

Turn the field diaphragm ring ① to make illumination area fit with eyepiece field of view.

If the Field diaphragm is bigger than the aperture required, external light will come into the viewing field, and will interfere with the quality of image and the contrast

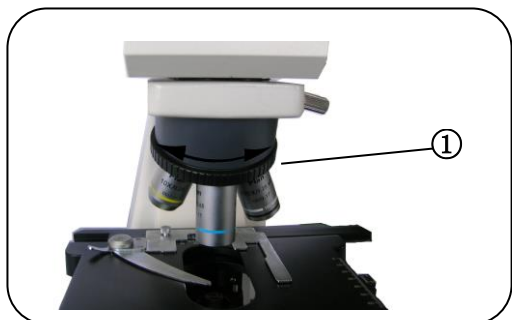

Fig. 11.

11. Switching between objectives (Fig. 11.)

Rotating the revolving nosepiece ① so that the required objective is pointing down over the specimen, make sure the nosepiece is clicked into the correct position.

12. Using 100X oil immersion objective (Fig. 12.) (only applicable if microscopes is upgraded and 100X objective is added)



Fig. 12.

To get a clear image using the 100X (oil) objective, place a drop of oil between the objective and slide.

- 1) Focus on the specimen at a lower magnification
- 2) Place a drop of oil on the slide exactly where you are observing the specimen before the 100X (oil) objective is moved into the path of light.
- 3) Rotate the nosepiece to move the 100X (oil) objective into light path, and adjust the fine focusing knob to obtain clearest image.

If there is an air bubble in oil, it will interfere with the clarity of the specimen. To remove the air bubble swing the objective lens into and out of place several times

- 4) After using the 100X (oil) objective carefully clean the oil off the objective with lens paper or a lint free towel. Do not use any water based solutions for cleaning.

VII. General maintenance

1. Replace the fuse (Fig. 13, Fig. 14 & Fig. 15)

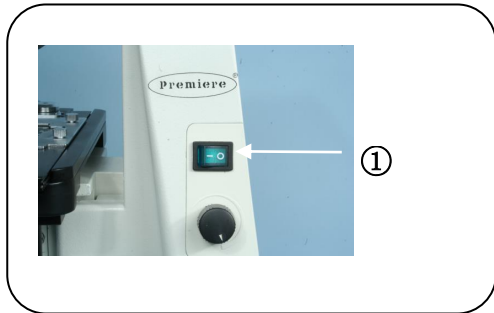

Fig. 13.

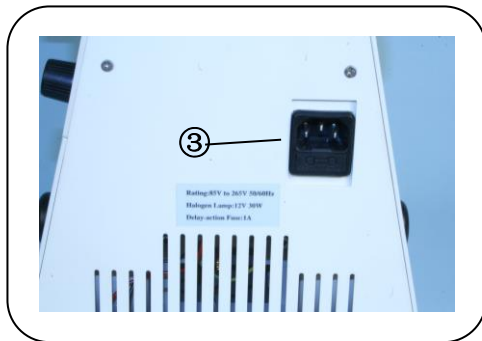

Fig. 14.

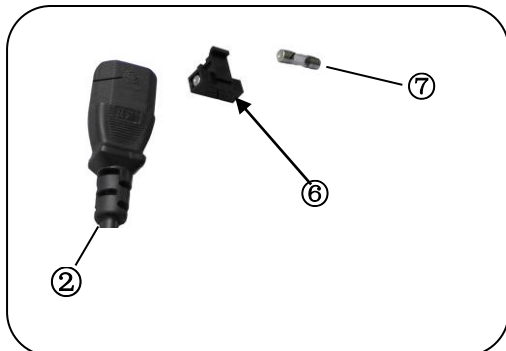

Fig. 15.

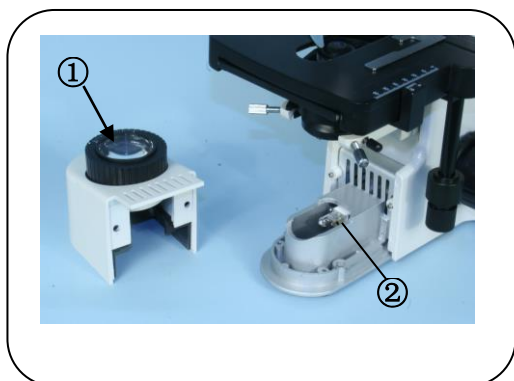

Fig. 16.

1. Turn the main power switch ① to "O" (OFF) before replacing the fuse.
2. Unplug and detach the power cord from the back of the microscope.
3. Use a flat head screwdriver and remove the fuse holder ⑥ under the cord holder ③ on the back of the microscopes.
4. Take out the fuse ⑦ from the fuse box ⑥, then replace it with a new fuse and re-insert the holder below the power cord socket.
5. Re-attach power cord and plug into power outlet.

2. Changing the bulb (Fig. 16.)

★ The electrical power must be disconnected when changing the bulb.

1. Pull the lamp cover off ① by sliding and gently removing the cover
2. The new halogen bulb ② should NOT be touched with your fingers or hands directly since the oils can damage the bulb. Always use lens paper or a glove to handle the bulbs during installation.
3. A fingerprint or dirt on the bulb will reduce the brightness and shorten the life of the bulb. Wipe down the bulb with lens paper after installation.
4. Replace the lamp cover ① after the bulb is changed.

Upon receipt of your new  *Microscope*
we recommend you record the following information for future reference:

Date purchased/received: _____

Premiere® Dealer: _____

Dealer's phone number: _____

Warranty

The manufacturer warrants this instrument to be free from defects in material and workmanship under normal use for five years from the date of purchase (one year for electrical components). It does not cover damage resulting from abuse or misuse, repairs or alterations performed by other than authorized repair technicians, or damage occurring in transit. If you have questions concerning this product or warranty, contact the dealer from whom it was purchased. For warranty service, microscope should be well packed to avoid damage in transit, preferably in original box and packing. Include your complete return address and telephone number as well as a description of the difficulty, date and place of purchase, and ship to the address below. It will be repaired or replaced at no charge and returned. If misuse, alterations, accident or abnormal conditions of operation caused failure, an estimate for repairs will be provided for your approval prior to work being performed.

Premiere Microscope Service Department
7241 Gabe Court
Manassas, VA 20109-2434

(25/2)

C & A Scientific Co., Inc.

Manassas • Virginia USA